

Varenummer: 3901150030100  
 Beskrivelse: Snekkegear med fri indgangsaksel  
 VF 150N-30-HS

## Mål

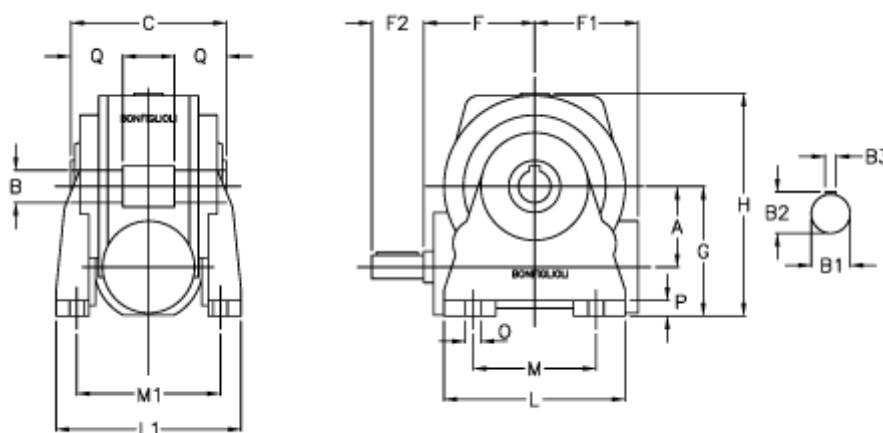

a	= 150.0	F1 = 179	O = 18.0
B	= 50	F2 = 65	P = 20
B1	= 35	g = 220	Q = 55.0
B2	= 38.0	H = 400.0	
B3	= 10	L = 330	
Betegnelse	= VF 150N-xx-HS	L1 = 260	
C	= 175	m = 240	
F	= 185.0	M1 = 211.0	